

# AL MIQAT HARDWARE

*Wire Mesh Experts*

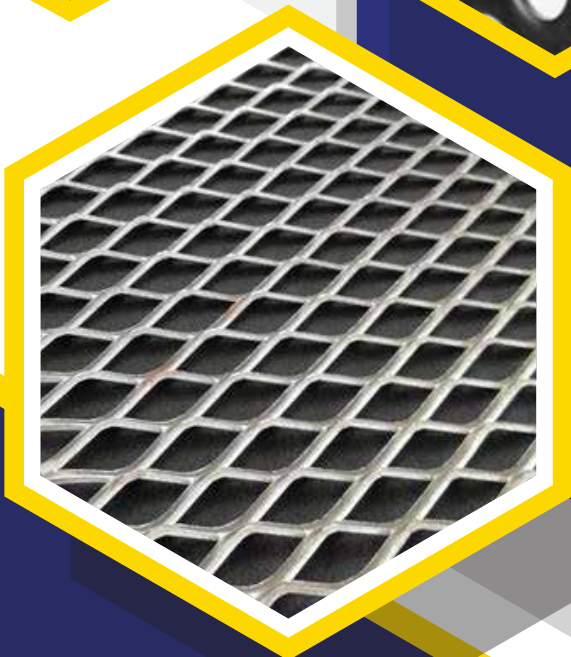
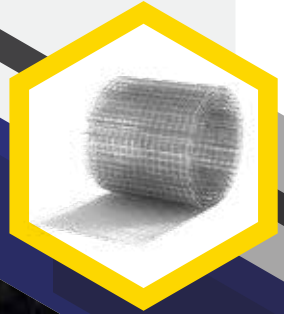
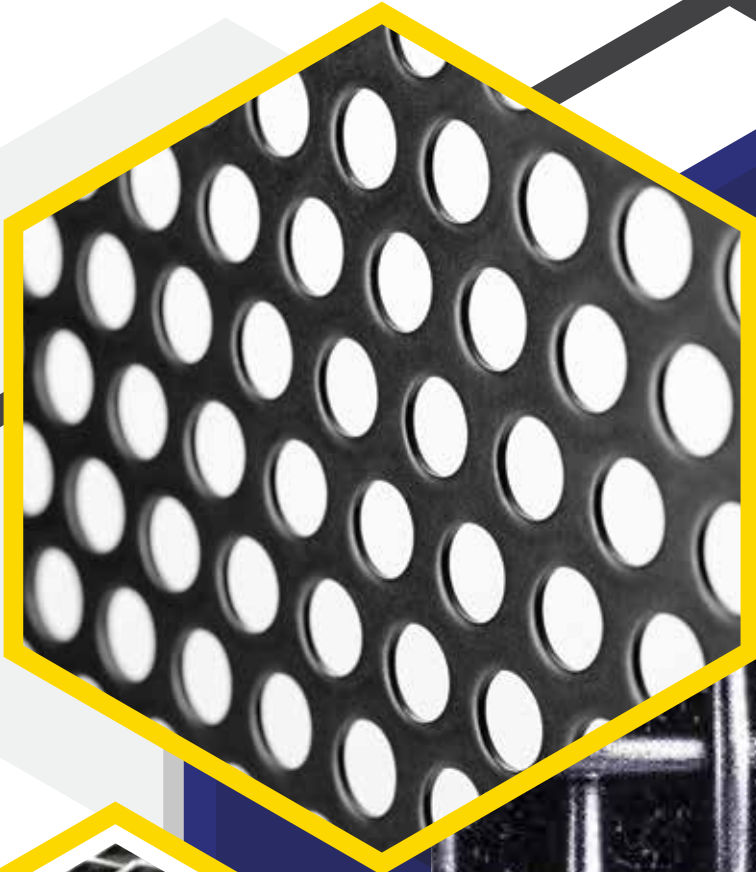

# Table Of Contents

---

About Us	01
Galvanized Welded Wire Mesh	02
PVC Coated Welded Wire Mesh	03
Stainless Steel Welded Wire Mesh	04
Stainless Steel Woven Wire Mesh	05-06
Wire Coils	07
Chain Link Fencing	08
Concertina Razor & Barbed Wire	09
Expanded Metal Mesh	10-11
Shade Netting	12
Hexagonal Wire Mesh & Fly Screen Mesh	13
Perforated Metal	14
Showrooms	15
Warehouses	16

---

## HISTORY

Al Miqat Hardware is professionally engaged in supply of wire mesh products and has close to 2 decade's worth of experience since 2005, in providing economical, adequate and timely solutions.

Today Al Miqat is known to be a market leader of wire mesh products in Galvanized, PVC Coated and Stainless Steel; Expanded Metal, Chain Link Fence, Wires, Perforated Metal, Shade Netting, Hexagonal Wire Mesh and Fly Screen Mesh.

Under the leadership and vision of its Managing Partner, Mr. Hashim Sherawala, company has grown in folds and provides adequate in-time Wire Mesh solutions to thousands of B2B and B2C customers spread across the GCC and the Africa each year.

Our strength lies in providing the best in-time solution as per our client requirements.

## VISION

Our vision is to keep growing and improving our performance in the industry while exceed our customers' expectations.

## MISSION

To continue providing right in-time solutions for our clients wire mesh requirements. To continue providing newer and stronger products in the region to build lasting relationships with all our clients.

# Galvanized Welded Wire Mesh



## Material: Electro Galvanized ( Roll )

Opening		Wire Diameter
Inch	MM	
1/4 x 1/4	6.4 x 6.4	18G, 20G
1/2 x 1/2	12.7 x 12.7	16G, 17G, 18G, 20G, 22G, 25G
3/4 x 3/4	19.1 x 19.1	16G, 17G
1 x 1	25.4 x 25.4	14G, 16G, 17G
2 x 2	50.8 x 50.8	10G, 14G, 16G

Standard Width : 3Ft - 6Ft    Standard Length : 50Ft / 100Ft

## Material: Electro Galvanized ( Sheet )

Opening	Wire Diameter
1 x 1	2.5mm, 2.7mm, 3mm, 3.5mm, 4mm
1 x 2	3mm
1.5 x 1.5	3mm
2 x 2	2.5mm, 2.7mm, 3mm, 3.5mm, 4mm, 5mm, 6mm, 8mm
3 x 3	5mm
4 x 4	4mm, 6mm, 8mm
6 x 6	6mm
8 x 8	6mm

Standard Sheet Size : 4Ft x 8Ft, 4Ft x 10Ft



# PVC Coated Welded Wire Mesh



## PVC Coated Welded Wire Mesh (Roll)

Opening		Wire Diameter
Inch	MM	
1/4 x 1/4	6.4 x 6.4	18G, 20G
1/2 x 1/2	12.7 x 12.7	16G, 17G, 18G, 20G, 25G
3/4 x 3/4	19.1 x 19.1	16G, 17G
1 x 1	25.4 x 25.4	14G, 16G
Standard Width: 3Ft - 6Ft		Standard Length: 50Ft / 100Ft

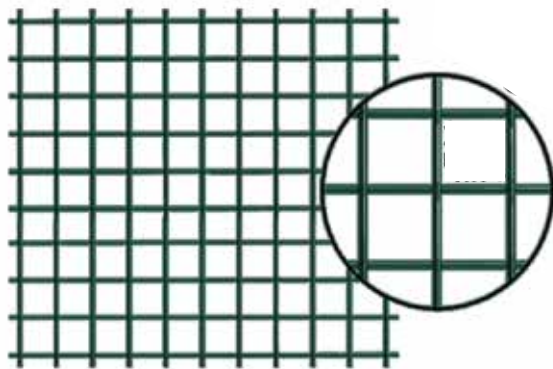

## PVC Coated Welded Wire Mesh (Sheet)

Opening	Wire Diameter
1 x 1	3mm
2 x 2	3mm, 4mm
Standard Sheet Size : 4Ft x 8Ft, 4Ft x 10Ft	

# Stainless Steel Welded Wire Mesh



## Stainless Steel Welded Wire Mesh (Roll)

Material		SS 304, 316, 316L
Opening		Wire Diameter
MM	Inch	
1/4 x 1/4	6.4 x 6.4	18G, 20G
1/2 x 1/2	12.7 x 12.7	16G, 17G, 18G, 20G, 25G
3/4 x 3/4	19.1 x 19.1	16G, 17G
1 x 1	25.4 x 25.4	14G, 16G

Standard Width : 1Mtr / 1.22Mtr / 1.5Mtr  
Standard Length : 50Ft / 100Ft

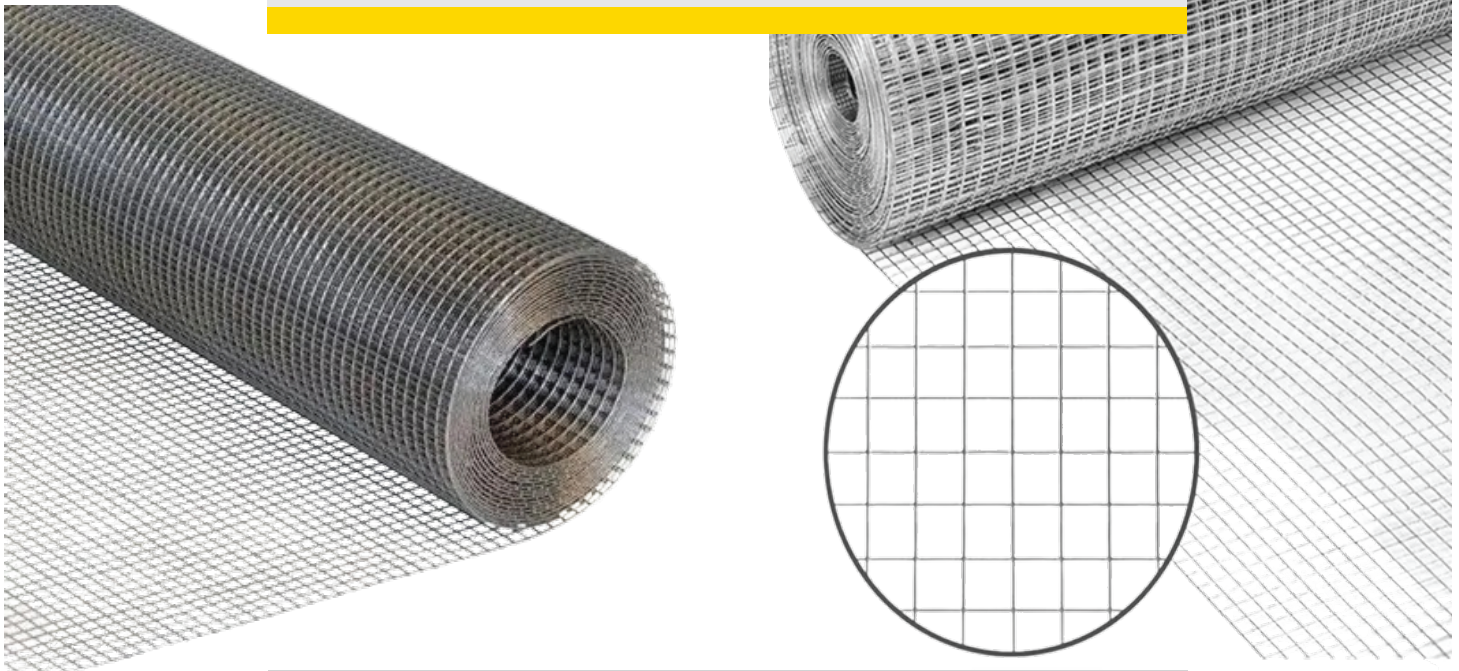

## Stainless Steel Welded Wire Mesh (Sheet)

Material		304, 316
Opening		Wire Diameter
1 x 1		2.5mm, 3mm, 4mm
2 x 2		3mm, 4mm, 5mm, 6mm

Standard Sheet Size : 4Ft x 8Ft, 4Ft x 10Ft

# Stainless Steel Woven Wire Mesh



## Stainless Steel Woven Wire Mesh

<b>Weaving Techniques</b>	Plain, Crimped, Dutch, Twill
<b>Available Materials</b>	201, 202, 304, 304L, 316, 316L, 308L, 321, Duplex 2205, 2207, 2900, 2304

Standard Width : 1Mtr / 1.22Mtr / 1.5Mtr

Standard Length : 50Ft / 100Ft

Mesh per Inch	Wire Diameter		Aperture		Open Area %
	Inch	MM	Inch	MM	
1 x 1	0.11	3.0	0.88	22.4	77.80
2 x 2	0.059	1.5	0.44	11.2	77.70
2 x 2	0.047	1.2	0.45	11.5	82.00
3 x 3	0.054	1.37	0.279	7.09	70.10
4 x 4	0.031	0.8	0.218	5.55	76.00
4 x 4	0.047	1.2	0.203	5.15	65.80
5 x 5	0.039	1.0	0.159	4.08	64.50
5 x 5	0.047	1.2	0.152	3.88	58.30
6 x 6	0.025	0.65	0.141	3.58	71.60
6 x 6	0.039	1.0	0.127	3.23	58.20
8 x 8	0.027	0.7	0.097	2.47	61.00
8 x 8	0.047	1.2	0.077	1.97	38.00
10 x 10	0.018	0.46	0.081	2.08	67.00
10 x 10	0.019	0.50	0.08	2.04	64.00
12 x 12	0.013	0.35	0.069	1.76	69.00
12 x 12	0.015	0.40	0.067	1.71	65.00
14 x 14	0.013	0.35	0.057	1.46	65.00
14 x 14	0.015	0.40	0.055	1.41	60.00
16 x 16	0.013	0.35	0.048	1.23	60.00
16 x 16	0.015	0.40	0.046	1.18	55.00



# Stainless Steel Woven Wire Mesh



Mesh per Inch	Wire Diameter		Aperture		Open Area %
	Inch	MM	Inch	MM	
18 x 18	0.011	0.30	0.043	1.11	77.80
20 x 20	0.019	0.50	0.03	0.77	37.00
20 x 20	0.016	0.40	0.034	0.86	46.00
20 x 20	0.01	0.27	0.039	1.00	62.00
24 x 24	0.014	0.35	0.0277	0.7	44.20
30 x 30	0.012	0.30	0.0213	0.54	40.80
30 x 30	0.007	0.18	0.0262	0.66	60.80
35 x 35	0.011	0.28	0.0176	0.45	37.90
40 x 40	0.014	0.25	0.015	0.38	36.00
40 x 40	0.007	0.18	0.017	0.45	50.00
50 x 50	0.005	0.15	0.013	0.35	47.00
60 x 60	0.005	0.15	0.01	0.27	40.70
70 x 70	0.0055	0.14	0.0087	0.22	37.00
80 x 80	0.0047	0.12	0.0077	0.197	38.80
90 x 90	0.0047	0.12	0.0061	0.16	30.00
100 x 100	0.0039	0.10	0.0060	0.15	34.80
120 x 120	0.0031	0.08	0.0051	0.1316	38.80
140 x 140	0.0027	0.07	0.0043	0.1114	37.80
160 x 160	0.0025	0.06	0.0038	0.0965	36.40
180 x 180	0.0023	0.05	0.0033	0.0838	34.70
200 x 200	0.0019	0.50	0.003	0.077	37.00
250 x 250	0.0016	0.0406	0.0024	0.061	36.00
270 x 270	0.0016	0.0406	0.0021	0.0533	32.20
300 x 300	0.0051	0.0381	0.0018	0.0457	29.70
325 x 325	0.0014	0.0356	0.0017	0.0432	30.00
400 x 400	0.001	0.0254	0.0015	0.37	36.00
500 x 500	0.001	0.0254	0.001	0.0254	25.00
635 X 635	0.0008	0.0203	0.0008	0.0203	25.00

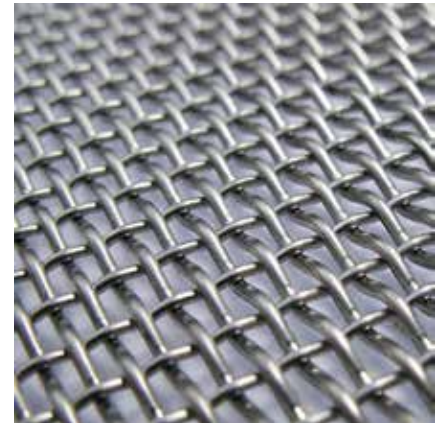



**Material  
Electro  
Galvanized**

**Material  
PVC Coated**

**Material  
Stainless Steel  
(Grade 304, 316)**

**Wire Diameter**

**Wire Diameter**

**Wire Diameter**

BWG	In Metric Unit
8	4mm
10	3mm
12	2.5mm
14	2mm
16	1.5mm
18	1.2mm
20	0.90mm
22	0.70mm

BWG	In Metric Unit
7	4.75mm
8	4mm
10	3mm
12	2.5mm
14	2mm
16	1.5mm
18	1.2mm

BWG	In Metric Unit
8	4mm
10	3mm
12	2.5mm
14	2mm
16	1.5mm
18	1.2mm
19	1mm
21	0.80mm
25	0.50mm



## Chain Link Fencing

Material				PVC Coated / Electro Galvanized / Hot Dipped Galvanized			
Opening		Wire Diameter		Height			
In Inch	In Merit Unit (MM)	In Merit Unit (MM)					
1 x 1	25 x 25	2.5, 3		3Ft - 20Ft			
1.5 x 1.5	40 x 40	2.5, 3		3Ft - 20Ft			
2 x 2	53 x 53	2.5, 3, 3.2, 4, 4.75		3Ft - 20Ft			
2.5 x 2.5	65 x 65	2.5, 3, 4		3Ft - 20Ft			

Length: As per requirement



# Concertina Razor & Barbed Wire



## Concertina Razor Barbed Wire

Material	Electro Galvanized
Diameter(CM)	Length (MTR)
45	4
60	7
90	10



## Barbed Wire

Material	Electro Galvanized, PVC Coated	
Material	Thickness	Length (MTR)
Electro Galvanized	2mm	200
PVC Coated	2.6mm	220



# Welded Fence

## PVC Coated Welded Fence (Roll)

Opening		Wire Diameter
Inch	MM	
2" x 2"	50.8 x 50.8	10G, 12G
Standard Width : 5Ft / 6Ft / 2Mtr		
Standard Length: 100Ft		



## Material: Electro Galvanized

Opening	Wire Diameter
5mm x 10mm	0.50mm
7mm x 12mm	0.60mm
8mm x 16mm	0.60mm
10mm x 20mm	1mm, 2mm, 3mm
15mm x 30mm	1mm, 2mm, 3mm
20mm x 40mm	2mm, 3mm
25mm x 50mm	2mm
30mm x 60mm	2mm, 3mm

Standard Width: 1Mtr / 1.22Mtr Standard Length: 10Mtr / 20Mtr  
Standard Sheet Size : 4Ft x 8Ft

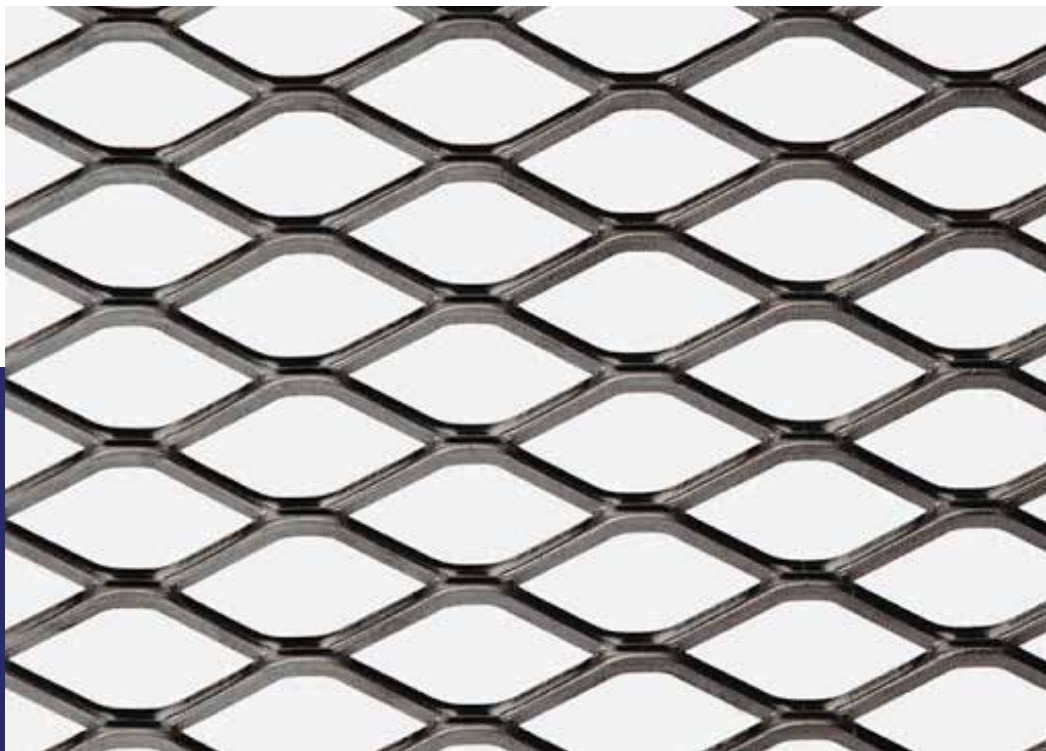

# Expanded Metal Mesh



## Material: Aluminium

Opening	Wire Diameter
3mm x 4mm	0.50mm, 1mm
5mm x 10mm	1mm
10mm x 20mm	1mm, 2mm
15mm x 30mm	2mm
20mm x 40mm	2mm
30mm x 60mm	3mm
Standard Width: 1.2Mtr Standard Length: 10Mtr Standard Sheet Size: 4Ft x 8Ft	

## Material: Stainless Steel (304, 316, 316L)

Opening	Wire Diameter
10mm x 20mm	1mm, 2mm, 3mm
12mm x 31mm	2mm, 3mm
20mm x 40mm	2mm
30mm x 60mm	3mm
Standard Width: 1.2Mtr Standard Length: 10Mtr Standard Sheet Size: 4Ft x 8Ft	

## Material: Mild Steel

Opening	Wire Diameter
30mm x 60mm	1.6mm, 1.8mm, 2.5mm, 2.7mm, 3mm, 4mm, 4.5mm, 6mm
Standard Sheet Size : 4Ft x 8Ft	



# Shade Netting



**Colour: Green, Beige, Black**

**Weight: 70GSM – 240 GSM**

Shade Factor	Width	Length
70%	2Mtr / 3Mtr	30Mtr / 40Mtr
75%	2Mtr / 3Mtr	30Mtr / 40Mtr
80%	2Mtr / 3Mtr	30Mtr / 40Mtr
85%	2Mtr / 3Mtr	30Mtr / 40Mtr
90%	2Mtr / 3Mtr	30Mtr / 40Mtr



**Colour: Green, Beige, Black, Desert Sand, River Gum, White, Blue, Dark Blue, Red, Yellow, Grey, Charcoal, Black**

**Weight: 325GSM, 340GSM, 380GSM, 440GSM (10Yrs Warranty)**

Shade Factor	Width	Length
95% Heavy Duty	3Mtr	50Mtr



# Hexagonal Wire Mesh



Material	Electro Galvanized	
Opening		Wire Diameter
Inch	MM	
1/2 x 1/2	12.7 x 12.7	20G, 22G, 25G
3/4 x 3/4	19.1 x 19.1	20G, 22G, 25G
1 x 1	25.4 x 25.4	20G, 22G, 25G

Standard Width: 1.2 Mtr Standard Length: 45 Mtr

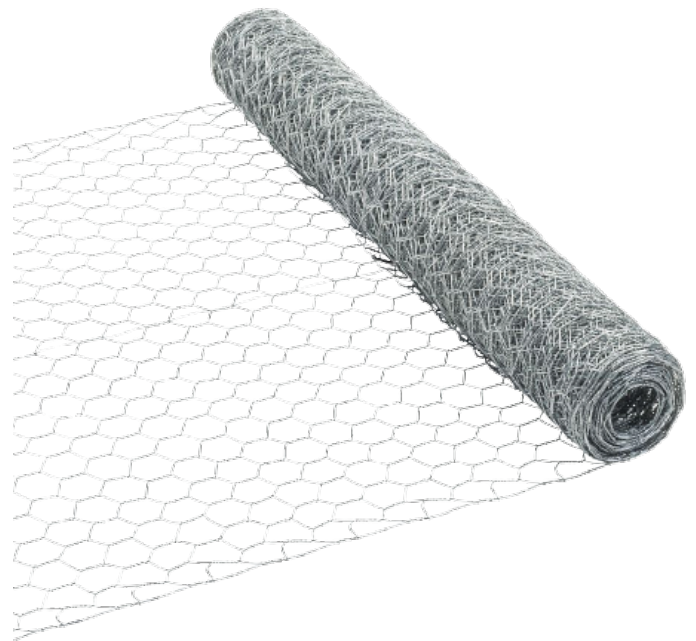

# Fly Screen Mesh

Material: Aluminium		
Opening	Width	Length
18 x 14	3Ft, 4Ft, 5Ft	20Mtr



**Material: Galvanized, Aluminium, Stainless Steel (304, 316L), Mild Steel**

Opening	Pitch	Sheet Thickness	Sheet Size
0.50mm	0.45mm	1.5mm	4Ft x 8Ft
0.80mm	2mm	0.80mm	4Ft x 8Ft
1mm	0.70mm, 1mm	2mm	4Ft x 8Ft
1.5mm	0.90mm	3mm	4Ft x 8Ft
3mm	0.70mm, 0.90mm, 1.2mm, 1.5mm, 2mm, 3mm	5mm	4Ft x 8Ft / 1Mtr x 2Mtr
4mm	1mm, 1.2mm	7mm	4Ft x 8Ft / 1Mtr x 2Mtr
5mm	0.90mm, 1.2mm, 1.5mm, 2mm, 3mm	7mm, 8mm, 10mm	4Ft x 8Ft / 1Mtr x 2Mtr
6mm	1.2mm, 1.5mm, 2mm, 3mm	8mm, 10mm	4Ft x 8Ft / 1Mtr x 2Mtr
8mm	1mm, 1.5mm, 2mm	12mm	4Ft x 8Ft / 1Mtr x 2Mtr
10mm	1.2mm, 1.5mm, 3mm	15mm	4Ft x 8Ft / 1Mtr x 2Mtr
12mm	1.5mm	18mm	4Ft x 8Ft
15mm	1.5mm	20mm	4Ft x 8Ft
20mm	1.5mm	30mm	4Ft x 8Ft

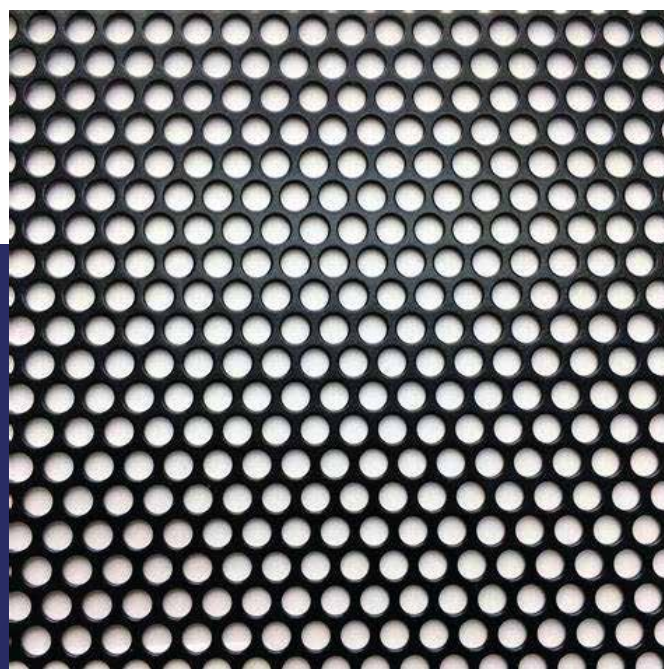



# Showrooms



**Phone :** +971 6 5664526

**Address :** P. O. Box 37752  
Shop # 9, Lateefa Abdulla Al  
Marzooqi Building Sedana Signal,  
Industrial Area # 2 Sharjah, UAE.

**Email :** sales@almiqathardware.com

**Phone :** +971 6 5434652

**Address :** Sedana Signal - Shop #4  
Industrial Area 1 - Al Nahdha  
Industrial Area - Sharjah  
United Arab Emirates.

**Email :** sales@almiqathardware.com

# Warehouses

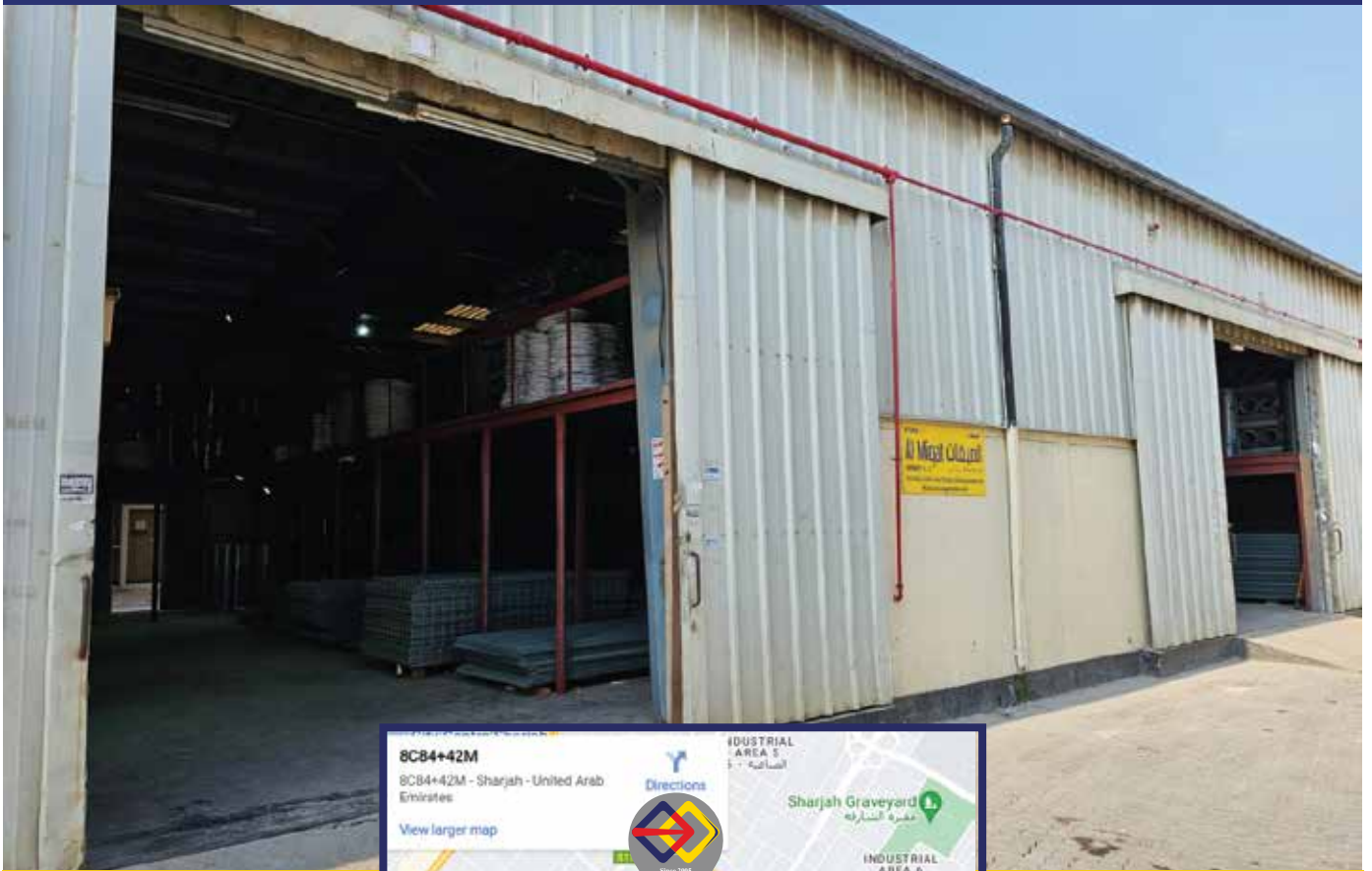

**Phone :** +971 6 5423852

**Address :** Warehouse 1 and 2,  
Opposite Igloo Ice Cream,  
Industrial Area # 2, Sharjah, UAE

**Email :** sales@almiqathardware.com



**AL MIQAT  
HARDWARE**  
Since 2005

Wire Mesh Experts



Since 2005

 **Phone Number**  
+971 6 5664526

 **Email**  
[sales@almiqathardware.com](mailto:sales@almiqathardware.com)

 **Website**  
[almiqathardware.com](http://almiqathardware.com)